

# VIMPEX

Battery Powered Hydraulic Tools



USAR

BC-300F Combi-Tool

Extrication

Forced Entry

Police

Remote Rescue

ORC Bar Cutters

Military

HRS Modular System

# Ogura & VimpeX

## Why Ogura?

Ogura was the first manufacturer in the world to develop a full range of truly portable, lightweight and powerful battery-powered hydraulic cutting, spreading and lifting tools. These tools are in use worldwide by rescue, military, police and security services.



Established in 1928 as a manufacturer of industrial products, Ogura has a long history of developing extremely reliable and hard working hydraulic tools for the construction, fabrication and metal working industry. In 1999 Ogura applied their knowledge of industrial hydraulics to the rescue and emergency services market to produce the first generation HRS Modular System. The range has now matured into an extensive series of tools.

## Why VimpeX?

Established in 1994 - VimpeX is a specialist supplier of fire fighting and rescue equipment as well as accessories and associated products to the emergency services (EMS), police, fire, USAR and military markets.

VimpeX is sole European distributor for the Ogura range of battery-powered hydraulic cutting, spreading and forced entry equipment and the Robopak battery backup system.

VimpeX staff are trained in the demonstration, service and repair of all tools and equipment we sell. We are the European warranty repair and service agent for all Ogura rescue and industrial tools.

We are active members of several trade bodies including FIRESA and the FIA. Our management systems, sales activities and service and repair operations are all accredited to ISO9001:2002.



Quality System Certificate No. 456  
Assessed to ISO 9001:2000

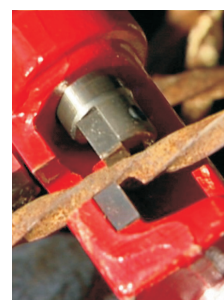
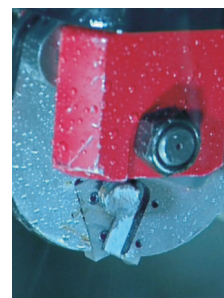

[www.rescue-tools.co.uk](http://www.rescue-tools.co.uk)



# Introduction

## Ogura Hydraulics

Ogura are world experts in compact hydraulics.

All Ogura tools use their patented pump design and operate at between 400 and 440 bar, which, whilst allowing for a compact pump body, gives incredible working power.



## Applications

Ogura tools are tough, powerful and portable tools for cutting, spreading, lifting and opening. The tools are ruggedised for military and security services operations and are extremely versatile. Applications include:

- Forced Entry (MOE)
- Vehicle & Confined Space Extrication
- Urban Search and Rescue
- Vehicle Self-Rescue
- Remote Decommissioning
- Protestor Release
- Aerial Response
- Rapid Response RTC Vehicles



## Li-Ion Battery Technology

All Ogura tools use the amazing Makita 18 V Li-Ion battery.



Recent tests by Ogura prove that the new Li-Ion units suffer a discharge rate of only 9% after 500 days in storage. Ogura are the only manufacturer of rescue tools with access to Makita batteries. Tests prove that the batteries used on Ogura tools have at least twice the life of other power tool batteries. Intelligent charging means that each individual battery has its own charge profile dependent on use. This extends battery life, increases durability and means 30% more cuts per charge. Recharge time is only 22 minutes. Both in-vehicle and mains-powered chargers are available.



## Service and Support

Vimpex staff are fully trained in Japan by Ogura engineers which allows for excellent customer service and quick response for repairs and service. A full inventory of spare parts is held in stock so wherever you are in Europe, we are able to supply spares within 48 hours.



## Customers

UK Police Forces, UK (MOD) Special Forces, UK Government USAR and National Resilience, Airport Fire Services, Local Authority Fire Brigades, Nuclear and Power Industry, UK Government Overseas Missions, Specialist Response Units, Military and Civilian Airports, Air Accident Investigation Teams.



## Storage, Carrying & Vehicle Solutions

Customers can specify moulded inserts for tool cases or vehicle trays. Moulded trays ensure tools, accessories and valuable batteries are returned to their correct location. Vehicle trays can also accommodate in-vehicle chargers so batteries are always fully charged and ready for use.

For a complete first response rescue package, consider combining Ogura Hydraulics with Makita battery-powered tools, all incorporated into a compact tray insert.



# HRS Modular Rescue System

The Ogura HRS battery-powered Hydraulic Rescue System is a portable, lightweight, compact and extremely versatile series of cutting, spreading and forced entry tools.



Totally modular in nature, the HRS system allows users to select only those tools suited to their tasks, thereby allowing professionals the freedom to purpose-build their battery-powered rescue system.



With the HRS system, simplicity is the key and due to the nature of its 'closed' hydraulic system, maintenance and training requirements are minimal.

The HRS Pump has been recently upgraded to incorporate a larger oil reservoir meaning we are now able to offer a 200 mm / 8" door opening tool.



All Ogura tools are supplied in sturdy plastic cases.

## Features

- Dedicated tools offer flexibility and ease of use
- Revolutionary hydraulic pump gives incredible power
- Connection either via hoses or directly to the pump
- Immediate deployment
- Single trigger grip allows extremely easy operation
- Very low maintenance
- New larger pump allows for 200 mm door opener



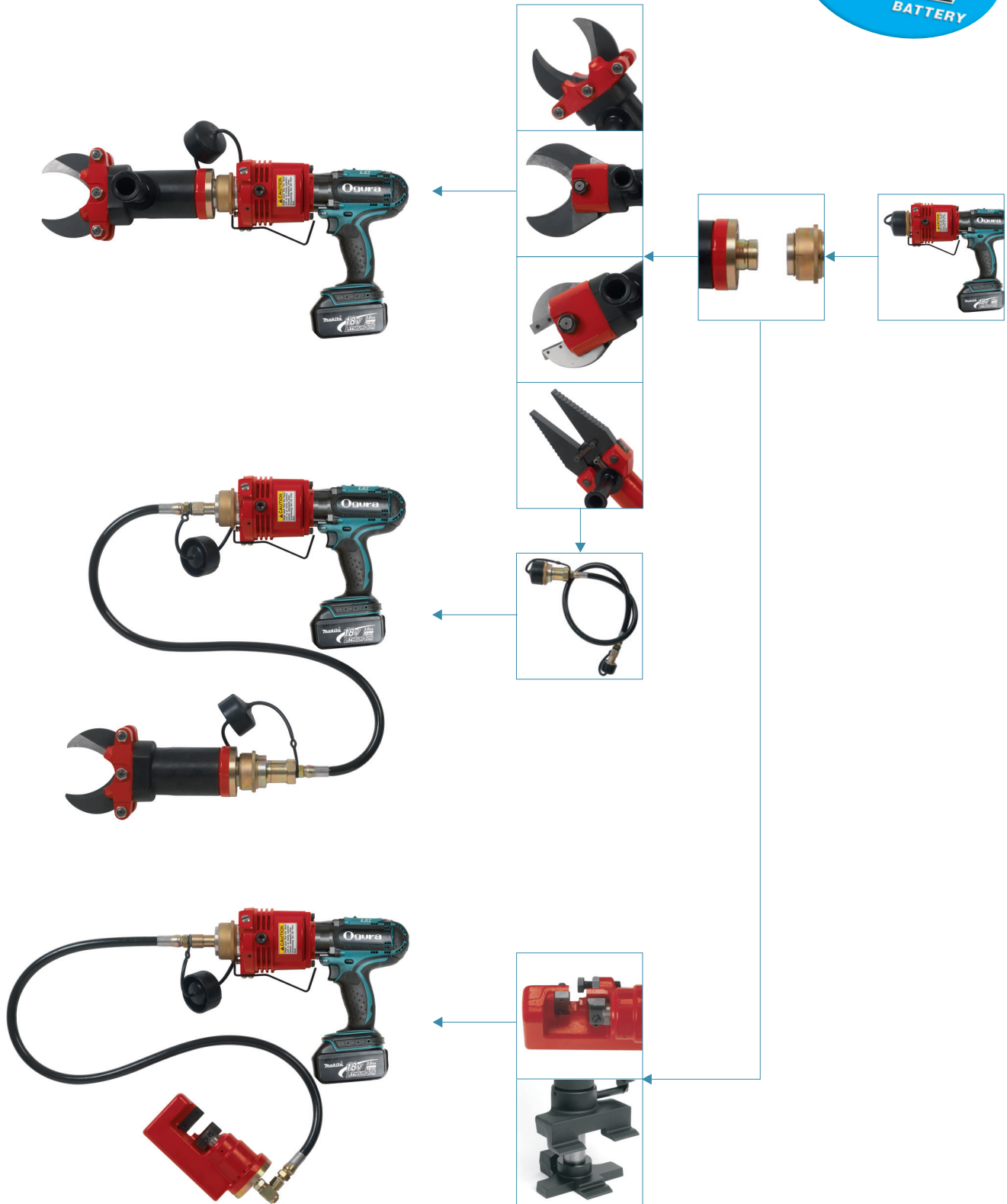

# HRS System Components



**HRS-941  
Hydraulic Pump**



Central to the HRS system's power is the battery powered pump that uses the amazing 18 V 3.0 Ah Li-Ion battery. The pump produces an impressive 400 bar and features an instantaneous coupling for swift and clean tool changes.

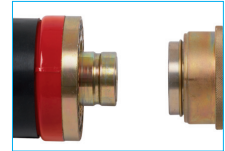

Tools can either be directly coupled or, for even more versatility, a flexible hose (up to 3 metres) can be used to connect the tools. The pump unit is supplied with an 18 V 3.0 Ah Li-Ion battery, 240 V ac charger and 1 m hose connector. In-vehicle 12/24 V dc and 110 V ac chargers are also available.

Weight	4.2 kg (including a battery, 0.6 kg)
Dimensions (L x W x H)	328x111x273 mm
Internal pressure (Max.)	39.7 - 40.2 Mpa
Oil quantity (ISO viscosity No. 32)	177 cc

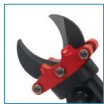

**HRS-922  
6 Tonne Metal  
Cutter**



Max. cutting force	5.8 tonnes
Max. cutter opening	72 mm
Weight	3.8 kg
Dimensions (L x W x H)	290x140x81 mm
Weight (connected to pump)	7.3 kg
Dimensions (connected to pump)	573x111x292 mm
Cutting Capacity:	
Round Bar-440 N/mm <sup>2</sup> (64,000 psi)*	8 mm
Flat bar-400 N/mm <sup>2</sup> (58,000 psi)*	70 x t3 mm
Flat pipe-290 N/mm <sup>2</sup> (42,000 psi)*	40 x t2 mm

\* Tensile strength



**HRS-932  
10 Tonne Cutter**



Max. cutting force	10.0 tonnes
Max. cutter opening	100 mm
Weight	6.2 kg
Dimensions (L x W x H)	382x186x104 mm
Weight (connected to pump)	10.1 kg
Dimensions (connected to pump)	664x111x273 mm
Cutting Capability:	
Rebar-440 N/mm <sup>2</sup> (64,000 psi)*	10 mm
Round bar-440 N/mm <sup>2</sup> (58,000 psi)*	10 mm
Flat bar-400 N/mm <sup>2</sup> (58,000 psi)*	80 x t3 mm
Round tube-290 N/mm <sup>2</sup> (42,000 psi)*	40 x t2 mm

\* Tensile strength



**HRS-932s  
Stubby Cutter**



Max. cutting force	8.0 tonnes
Max. cutter opening	26 mm
Weight	5.5 kg
Dimensions (L x W x H)	328x130x104 mm
Weight (connected to pump)	10.1 kg
Dimensions (connected to pump)	664x111x273 mm
Cutting Capacity:	
Rebar-440 N/mm <sup>2</sup> (90,000 psi)*	16 mm
Round bar-400 N/mm <sup>2</sup> (58,000 psi)*	16 mm
Round tube-400 N/mm <sup>2</sup> (58,000 psi)*	25 x t3.2 mm
Square tube-400 N/mm <sup>2</sup> (58,000 psi)*	25 x 25 x t3.2 mm

\* Tensile strength







### HRS-933 16mm Bar Cutter

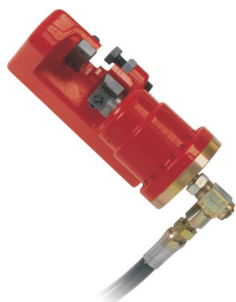

Max. cutting force	7.2 tonnes
Weight	5.2 kg
Dimensions (L x W x H)	228x105x84 mm
Cutting Capacity:	
Rebar-440 N/mm <sup>2</sup> (64,000 psi)*	16 mm
Flat bar-400 N/mm <sup>2</sup> (58,000 psi)*	38 x t6 mm
Flat pipe-290 N/mm <sup>2</sup> (58,000 psi)*	14 x 14 mm

\* Tensile strength

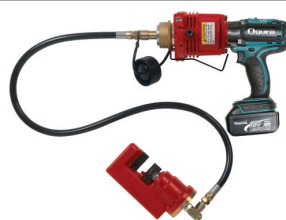

Bar stabilisation  
bolt for true  
control

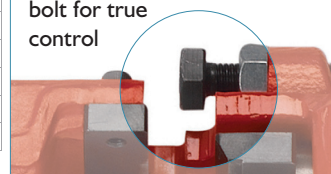

### HRS-934 4 Tonne Spreader



Spreading force (at tips)	4.0 tonnes
Opening distance	158 mm
Weight	5.4 kg
Dimensions (L x W x H)	352x121x78 mm
Weight (connected to pump)	9.3 kg
Dimensions (connected to pump)	634x111x279 mm



### HRS-936/946 Door Opener/Jack

Method of Entry (MOE) and other tactical users requiring tools for breaching and door opening operations can choose between two specialist Ogura tools. HRS-936 is a very compact tool with 4 tonnes of power. HRS-946 has a larger 205 mm opening and 3.5 tonnes of lifting force. Both tools are ideal for door opening and breaching operations. When in the closed position both tools have very thin, but very tough, 3 mm blades. A strike plate on each of the tools allows users to force the tools into tight gaps in doors and panels. Both tools have a handy rubberised handle to aid carrying and positioning.

#### HRS-946

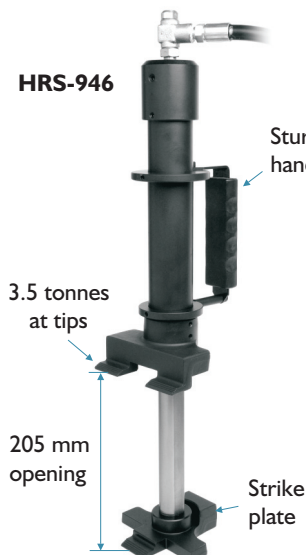

#### HRS-936

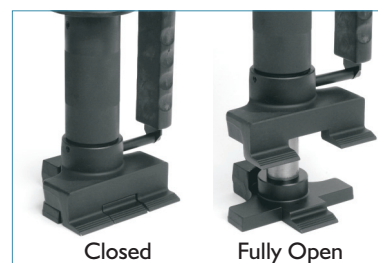
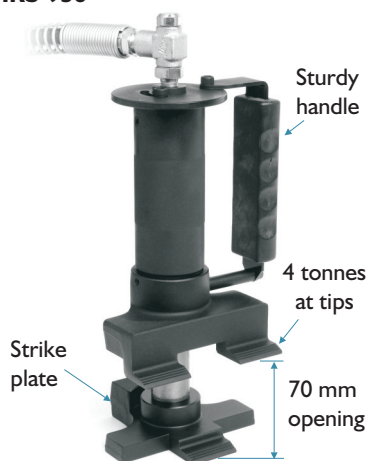

# BC-300F Combi Tool

The BC-300F Combi-Tool is absolutely unique for the following reasons:

1. It is the lightest in its class.
2. It is the only one using Makita Li-Ion batteries and offering in-vehicle charging
3. It is the only tool to use removable, field-replaceable blade inserts.

At only 14.2 kg, this is the lightest battery-powered Combi-Tool around. As Ogura is the only rescue tool manufacturer with access to Makita batteries, the BC-300F can boast the most advanced power source available with in-vehicle charging options. Able to cut 25 mm bar with a spreading distance of 300 mm and a maximum spreading force of 44.8 tonnes - this battery-powered Combi-Tool will not let you down.

Very narrow in profile, the BC-300F can be held close to the body whilst in use which maximises control and user safety.

In short, the Ogura tool is the most ergonomic of all battery-powered Combi-Tools.

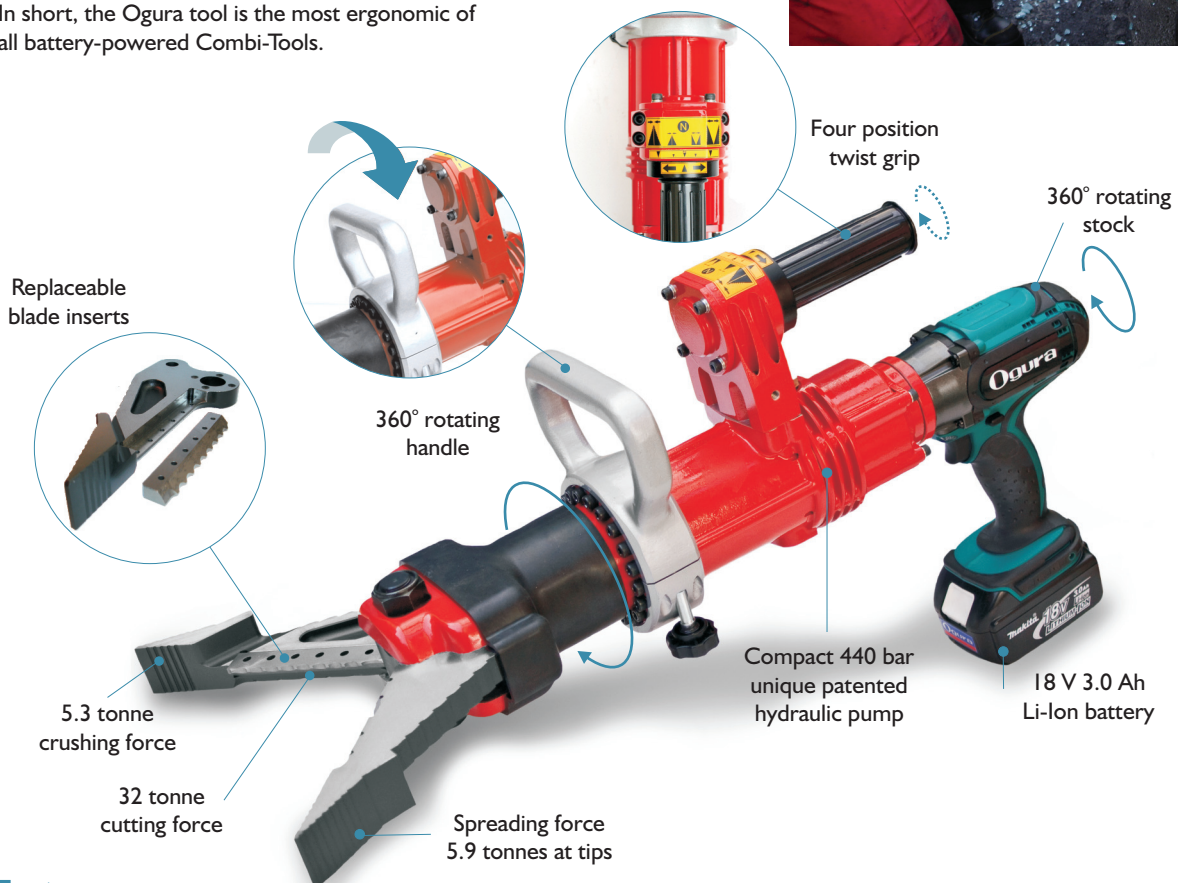

## Features

- Low cost removable blade chips significantly reduce cost of ownership
- Field-replaceable blade inserts
- Lightweight and compact; offers real portability
- Revolutionary hydraulic pump gives incredible power
- No trailing hoses to trip over
- Immediate deployment
- 300 mm 5.2 tonne spread
- 32 tonne cutting pressure
- Maximum spreading force 44.8 tonnes

Performs to EN13204  
BK33.2/300-F-14.2





# BC-300F Performance

## ENI3204 - Double acting hydraulic rescue tools for fire and rescue service use

This standard, although not universally accepted by all tool manufacturers, does give a useful guide to a tool's cutting capability. The Ogura Combi-Tool's classification is:

# BK33.2 / 300 - F - 14.2

↑ Spreading Force - 33.2 kN      ↑ Spreading Distance - 300 mm      ↑ Cutting Capability (See Table)      ↑ Total Mass with Battery (kg)



### Cutting Capability

The BC-300F's unique replaceable blade chips have amazing cutting power and have been proven to be ultra-durable.

Cutting Capability According to ENI 3204:

- Hot Rolled Round Bar: 25 mm
- Flat Bar: 80 x 10 mm
- Round Tube: 60.3 x t2.9 mm
- Square Hollow Tube: 50 x t4 mm
- Rectangular Hollow Tube: 60 x 40 x t3 mm
- Rebar: 22 mm\*
- Angle: 45 x 45 x t6 mm\*

\* Non-EN-I 3204 materials

### Specification

- A** Max. cutting opening: 205 mm
- B** Cutting force in the notch: 32 tonnes (313.8 kN)
- C** Max. cutting force at the centre: 11.8 tonnes (115.7 kN)
- D** Max. Spreading distance: 300 mm
- E** Spreading Force at tips: 5.2 tonnes (51 kN)
- F** Spreading Force 25 mm from tips: 5.9 tonnes (57.9 kN)

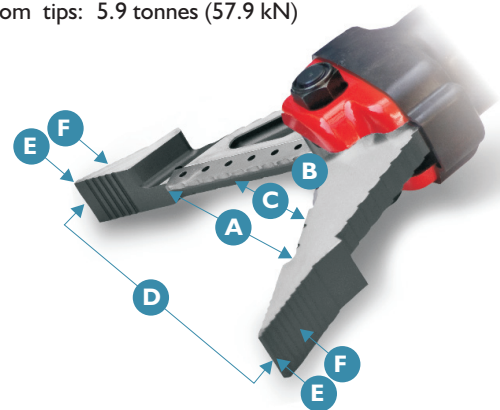

A tool can only claim conformity to ENI 3204 if each of the 5 materials above are able to be cut 15 times with one blade with no damage (total 75 cuts). The Ogura tools with their extremely durable blades of course far exceed this requirement.

## MCT-250 Manual Combi-Tool

Immediately deployed, hand operated combi-tool for confined space, remote rescue and hazardous area operations.

### Features

- Double handle for easy operation
- Unique replaceable blade chips
- Completely self-contained
- Shares many features with BC-300F
- Lightweight and very portable



# ORC Portable Bar Cutters

For rescue teams requiring a dedicated bar cutter to ease the extrication of casualties from buildings affected by collapse by earthquake, explosion or collision, the two ORC bar cutting tools offer unrivalled performance and power. These tools have extreme run times - over 100 cuts on one battery charge.

The ORC-16 is capable of shearing through 16 mm rebar, whilst the ORC-19 makes easy work of 20 mm bar. With very quick cutting speeds and safe use, the ORC tools are also ideal for forced entry into buildings, removal of illegally parked bicycles and motorbikes and for protestor release during political demonstrations. Mains powered versions are available, which will cut up to 32 mm rebar.



## ORC 19 Battery-Powered 20 mm Rebar Cutter

Used by UK Fire & Rescue  
USAR Teams

Can cut 20 mm rebar!

Will cut 20 mm rebar, chain, bike locks and padlocks!

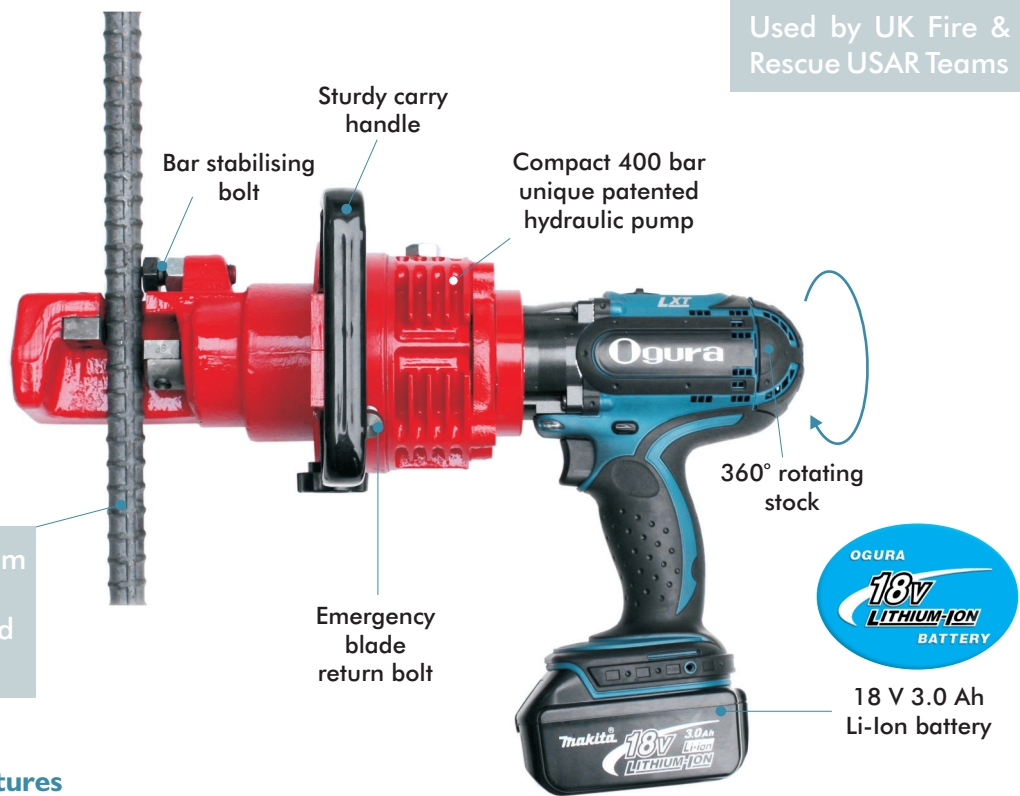

18 V 3.0 Ah  
Li-Ion battery

### Rebar Cutter Features

- Battery-powered - able to cut 20 mm rebar
- Mains-powered - able to cut 32 mm rebar
- Ideal for Protestor Release - can cut through D-Locks
- Very quick in operation
- Cuts bike locks, high tensile steel and steel cable
- Very durable specially heat treated blades

### Mains-Powered Rebar Cutters

Cuts up to 32 mm rebar



HBC-225











HBC-232



# Ogura Accessories

A full range of accessories are available to support Ogura Hydraulic Tools, including batteries, chargers and blades:

## Blades & Accessories

Description	Part No.		Description	Part No.	
HRS-922 shear blade	5100190		BC-300 blade holder	5100320	
HRS-932 shear blade	5101300		BC-300 blade chips	5100310	
HRS-932(s) blade holder	5101310		Chain Pulling Attachment with chains for BC-300/MCT-250	BC-300/CHAINS	
HRS-932(s) blade chip	5101320		HBC-225 blade set	9002040	
ORC-16HPW blade set	9002470		HBC-232 blade set	9002460	
ORC-19 blade set	9002030				

## Batteries and Chargers

Description	Part No.		Description	Part No.
18 V 3.0 Ah Li-Ion Battery	BL1830		RoboPak with 18 V Makita Adaptor and UK Charger (four times the run time of a standard battery)	ROBO/UK/MAK18V
Li-Ion Charger (UK)	DC18RA/240UK			
Li-Ion Charger (EU)	DC18RA/240EU			
Li-Ion Charger (110 V) (UK)	DC18RA/I			
Li-Ion Charger 12/24 V (In-vehicle)	DC18SE			

# Robopak - Variable Voltage Battery Packs

## Are you tired of running out of power at critical times?

Frustrated with constantly purchasing different types of power tool batteries?

Would you like a single battery system that can run all of your battery-powered tools and lights with more reliability and greater run time?

## Robopak

The answer is the Robopak Variable Voltage Battery Pack. Lightweight and easy to transport, Robopaks are heavy-duty, all-weather battery systems that provide reliable DC power.

With multiple voltage and multiple amperage capabilities, a single Robopak can power infinite brands of tools, lights and equipment. Robopak units suffer from no memory problems and can be left on trickle-charge if needs be.



## Robolight - LED Scene Lighting

The next generation of scene lighting. Eliminate the high cost of lamp or ballast replacements!

Extremely bright and efficient - These 12 V LED scene lighting systems are portable and can be used in all weather conditions. They are easily stored in your vehicle to provide light where and when you need it.

Our LEDs utilise the latest solid-state electronics that is extremely durable and are encased in an all-weather heavy-duty rugged aluminium housing. The portable telescoping tripod is made of anodized aluminium.

Two power versions are available; 5,000 or 10,000 lumens. The tripod can extend to approximately 2.6 m in height (also available in a shorter 1.7 m height version).

This LED Scene Light can either be powered externally or by our variable voltage Robopak battery system, allowing scene lighting in the most remote locations. Use of the Robopak also provides great flexibility as the system can be used to power all sorts of power tools as well as the Robopak LED Spot Lights.



Robopak LED Spot Light

 **Vimpex Ltd**  
Star Lane, Great Wakering  
Essex SS3 0PJ England  
Tel: +44 (0) 1702 216999  
Fax: +44 (0) 1702 216699  
E-mail: sales@vimpex.co.uk  
[www.vimpex.co.uk](http://www.vimpex.co.uk)

DS/OGU/ISS 8

 **Vimpex-Interguard AB**  
Tel: +46 (0) 36 37 10 65  
E-mail: sales@vimpex.se  
[www.vimpex.se](http://www.vimpex.se)

  
Advancing Rescue Technology